

Data Sheet



Article number: 021816011145

Description: Clamp with bracket and rubber
SPGU 6011. 145/30 SK

Measures

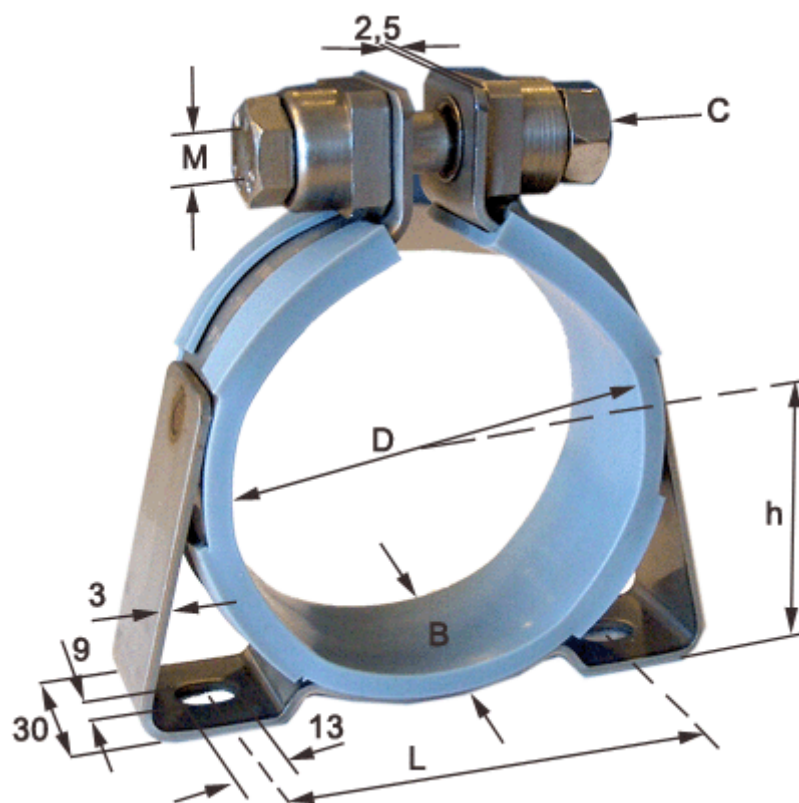

C (screw type) = SK hexagon screw

Diameter D = 145

h = 81

L = 136

Width B = 30